



ОБЩЕЕ ОПИСАНИЕ

The most important feature of LTK series position sensors is that they have a rodless and sliding system. They take measurement by movement of the sled along the profile. This provides the body to be shorter and allows up to 1000 mm stroke lengths.

They work as ABSOLUTE because they are measuring with the potentiometric principle, that is, they do not lose their position in case of power off. Potentiometric, 4-20 mA (optional 0-20 mA) or 0-10V analog output options are available.

Because of their linearized conductive plastic resistance alloy and special contacts, they are not affected by wear and operate for a long time with a life cycle of up to 100 million. They are stable by being linear and they measure evenly.

- Rodless, sliding system
- Measuring lengths between 50 mm and 1000 mm
- Potentiometric measurement
- Potentiometric, 4-20 mA or 0-10V analog output options
- Long life up to 100 million movements
- High accuracy
- Compact design
- DIN43650-A socket connection
- IP 40 protection class (if slider is mounted upside down, it becomes IP54)

TECHNICAL SPECIFICATIONS

Model	LTK 50	LTK 75	LTK 100	LTK 125	LTK 150	LTK 175	LTK 200	LTK 225	LTK 250	LTK 275	LTK 300	LTK 325	LTK 350	LTK 360	LTK 375	LTK 400	LTK 450	LTK 500	LTK 550	LTK 600	LTK 650	LTK 700	LTK 750	LTK 800	LTK 900	LTK 1000	
Electrical Stroke (mm)	50	75	100	125	150	175	200	225	250	275	300	325	350	360	375	400	450	500	550	600	650	700	750	800	900	1000	
Resistance (KΩ)	5	5	5	5	5	5	5	5	5	5	5	5	5	5	5	5	5	5	5	5	10	10	10	10	10	10	
Resistance Tolerance (±%)	20																										
Independent Linearity (±%)	0,1																										
Repeatability	0.01 mm																										
Operating Speed	≤ 5 m/s																										
Resistance Element	Conductive Plastic																										
Output Signal	4-20 mA (optional 0...20 mA), 0-10V or Potentiometric																										
Supply Voltage	For Current and Voltage output models: 12...30 VDC For potentiometric output model: 42V max.																										
Electrical Connection	DIN 43650-A 4 pin socket																										
Mechanical Fixing	Adjustable (sliding) mounting feet																										
Operating Temperature	-30°C...+100°C																										
IP Protection Class	IP40 (if slider is mounted upside down, it becomes IP54)																										
Life	100 x 10 ⁶ movements																										
Material	Sliding parts: Plastic Body: Aluminum																										

MECHANICAL DIMENSIONS (mm)

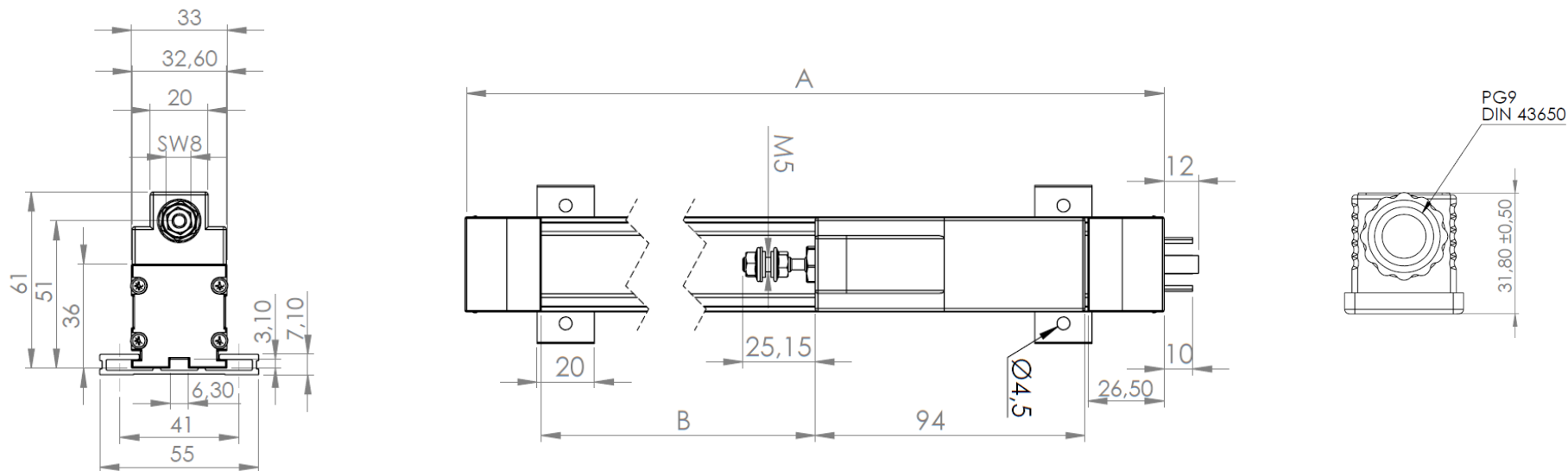

MODEL	50	75	100	125	150	200	225	250	275	300	325	350	360	375	400	450	500	550	600	650	700	750	800	900	1000
Electrical Stroke (mm)	50	75	100	125	150	200	225	250	275	300	325	350	360	375	400	450	500	550	600	650	700	750	800	900	1000
Mechanical Stroke (B) (mm)	54	79	104	129	154	204	229	254	279	304	329	354	364	379	404	454	504	554	604	654	704	754	804	904	1004
Body Length (A) (mm)	205	230	255	280	305	355	380	405	430	455	480	505	515	530	555	605	655	705	755	805	855	905	955	1055	1155

ELECTRICAL CONNECTION

SIGNAL	DIN 43650-A SOCKET
+ V	Pin 1
Output Signal*	Pin 2
- V	Pin 3

* **Output Signal** may be potentiometric, 0-10 VDC or 4-20 mA depending on the model (See Product code table).

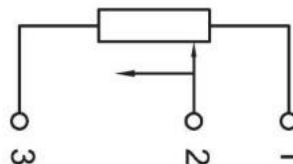
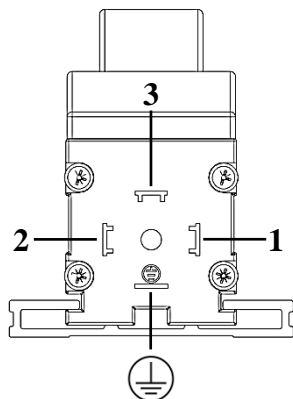

Potentiometer Connection (Voltage Divider)

Note: The GND line of the feed and signal output is common. Therefore it can be connected with 3-wire cable.

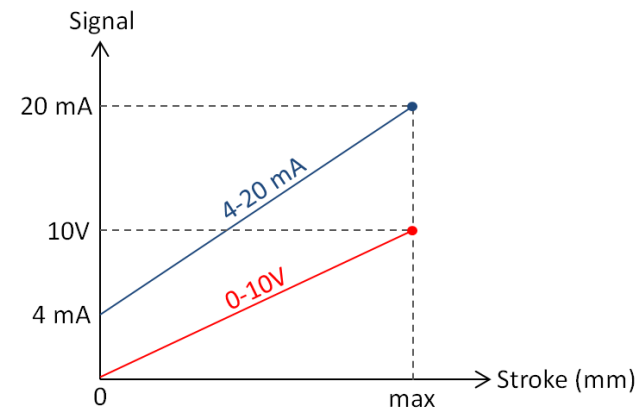

SAMPLE APPLICATION FIELDS

- Measuring /control technology
- Manufacturing engineering like woodwork machines, riveting machines, packaging machines etc.
- Hydraulic machines
- Press brakes
- Metal working machines
- Bending machines
- Assembly and test equipment
- Medical applications
- Building technology
- Textile machinery
- Plastic and metal injection machines

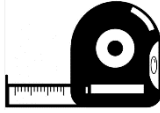
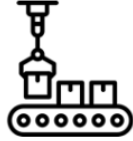



ORDER CODE

Model No				Resistance Value				Electrical Connection		
L	T	K	-	X	-	X	-	X	-	X
				5K: 5KΩ 10K: 10KΩ				No code: DIN43650-A Socket (standard)		
				Measuring length (Stroke) Different measuring lengths between 50 mm and 1000 mm				Output Signal A: 4-20 mA (*Optional 0-20 mA) V: 0-10 VDC No Code: Potentiometric		

Sample Code: LTK-1000-10K-A
 LTK series, 1000 mm stroke, 10K resistance, 4-20 mA output, DIN43650-A socket

Atek Sensor Technology

 Tuzla KOSB Organize Sanayi Bölgesi Melek Aras Bulvarı, No:67 34956 Tuzla-İstanbul / TURKEY

 Tel: +90 216 399 44 04

 Fax: +90 216 399 44 02

 www.ateksensor.com

 info@ateksensor.com